

Table of Contents

You Are What You Eat	2
Un drôle de truc pour apprendre du sérieux!	4
The Entrepreneurship Club	5
Appendix A – Container and Wrapping Information.....	7
Appendix B – Loyalty Program Information	8
Appendix C – Formula Sheet	9
Appendix D – Answer Key.....	10
Burning Questions.....	13
Appendix A– Burning Questions.....	14
Appendix B – Answers for Burning.....	17
The Importance of Healthy Snacking!.....	18
What Is Reconciliation?.....	19
Growing Pains.....	20
Appendix – Growing Pains	25

You Are What You Eat

Information for students

- Over the last two months the way we eat has changed. We can't go to restaurants, we may be ordering takeout more often, some grocery store staples might be hard to find, and families are cooking their meals at home more often. People have decided to learn how to bake bread or try new recipes; some young people might be learning how to make family favourites for the first time.
 - This lesson asks you to gather ideas about the relationship between food and culture and then to use non-fiction writing to examine your own ideas on the topic. How does food influence and define our identity and our humanity?
1. Watch the video "Cultural Identities Served with Food" (4min 30sec): <https://safeyoutube.net/w/Fqhl>
 - What connection does the video make between culture and food? What do the people interviewed say about how their identity/culture is connected to food?
 2. Read the two articles linked here and gather information about the topic in the chart below:

What Food Tells Us About Culture	On Mickey Mouse Prosciutto, the Loss of Food Culture and Why Garlic Makes Everything Better
What is the main idea of this article?	What is the main idea of this article?
Evidence you found that supports the main idea: <ul style="list-style-type: none"> • • • 	Evidence you found that supports the main idea: <ul style="list-style-type: none"> • • •

3. Each article expresses a different perspective about the ties between what we eat and our culture. Can you think of an example of a food you would immediately associate with your family, your culture, Canada or the region of Canada in which you live?

English Language Arts

4. Develop your ideas: Write a text (article, blog post, personal essay, memoir, poem, etc.) to share your thoughts on your relationship with food and how it does or does not connect to your identity. You might consider the following:
 - Is there a clear relationship between food and culture in Canada? Is it easier to identify connections between food and culture in countries like China, France, and Italy than it is in North America where many cultures have come together? Would Canada experience a loss of food culture if we didn't have one to begin with?
 - Reflect on how the multicultural makeup of Canada is part of the relationship between food and culture in Canada. What foods would you call "Canadian"?

For more interesting information on food culture to help you develop your stance you could read/view the following:

[Losing Food Identity](#)

[The Role of Food in Human Culture](#)

[Why We Need to Reclaim Vanishing Food Culture](#)

Materials required

- Videos and articles
- Device with Internet access
- Paper and writing materials

Information for parents**About the activity**

Children should:

- view and discuss the video with a parent or family member
- read and discuss the articles with a parent or family member
- write their thoughts down on paper or using an electronic device
- create a text that expresses their thoughts on how culture/identity and food are connected
- choose the medium they feel suits their purpose the best (art, writing, video, etc.)

Parents could:

- discuss the instructions with their child

Un drôle de truc pour apprendre du sérieux!

Consignes à l'élève

Suivre les consignes suivantes:

- Écoutez cette courte [capsule vidéo](#);
- Exercez-vous avec les exercices suivants : [activité 1](#) et [activité 2](#).
- Corrigez-vous automatiquement après chaque activité.

Matériel requis

- un appareil avec accès à Internet

Information for parents

Children should:

- watch the short clip as many times as needed
- complete the two sets of activities online
- check their answers by clicking the yellow correction button
- try to understand their mistakes

Parents could:

- help their child understand any answers they missed

The Entrepreneurship Club

Information for students

The Entrepreneurship Club has come up with a plan to sell homemade cookies and chocolates at school events.

- They originally thought about selling big packages of cookies and chocolates to groups of friends. They handed out surveys, and the results indicated that people would consider buying the following two packages:
 - 5 cookies and 8 chocolates for \$44
 - 7 cookies and 3 chocolates for \$37
- However, the feedback they got was that most people didn't want to buy a large package of treats, but rather buy the cookies and chocolates separately.
- **Given their survey results, how much would they be charging for each cookie and each chocolate?**
- The Entrepreneurship Club would still like to sell a package for friends to share. They've come up with the "Triple 10 Deal," where if a group buys 10 cookies and 10 chocolates, they'll save \$10 on the total price. **How much would that package cost?**
- The Entrepreneurship Club would nevertheless also like to sell separate packages of cookies and chocolates. They will need to buy wrapping paper for the cookie container and the chocolate box. They also want to create a loyalty program to encourage people to keep buying their products at school events.
- At this point, the activity will be split into two:
 - Students in the Secondary IV SN Math course will determine the amount of wrapping paper needed as well as the cost of producing each package.
 - Students in the Secondary IV CST Math course will create the loyalty program.
- To save money, the group wants to buy precut wrapping paper that they could use to wrap the cookie container and the chocolate box. The students will be designing the packaging for both. They would like the cookies to be in a cylindrical container and the chocolates to be in a rectangular box.
 - **Given the diagrams and information provided in Appendix A, what should be the height of the cookie container to make the areas equivalent for wrapping?**
 - **How many chocolates will be in each box and how many cookies will be in each container?**
 - **What will be the total cost of all the materials for each package (food, container and wrapping)?**

- The Loyalty Program team has looked at several different options for their loyalty program. These options are outlined in Appendix B.
 - **Draw the graphs to show how each the loyalty program option works.**
 - **Which option will be the best for their business (meaning that that customers will like the program, but it won't cut into their profits too much)?**
 - **Defend your decision by coming up with an argument for why one option is better than the others.** *Note: For this section, there is no "right" answer. All three choices have their pros and cons.*

Materials required

- Appendix A: Container and Wrapping Information
- Appendix B: Loyalty Program Information
- Appendix C: Formula Sheet
- Appendix D: Answer Key

Information for parents

About the activity

- read the instructions to your child, if necessary
- discuss the task together with your child, outlining what steps they need to carry out
- the CST portion of this activity does not have a conclusive final answer. Students are expected to draw a graph for each option and then present an argument for their decision as to which loyalty plan is the best in comparison with the other plans
- once the task is completed, you and your child can go over the task with the answer key provided (Appendix D)
- your child may obtain answers that could be slightly different from the answer key (geometry section only), depending on how they round off their results. Being off by a few tenths is fine. There is no need to worry about inconsistencies in rounding off the results. The important thing is that your child is able to show that they can solve the problem

Appendix A – Container and Wrapping Information

Dimensions of the Container

- Images are not necessarily drawn to scale.
- Represented below are a cylinder and a square-based prism.

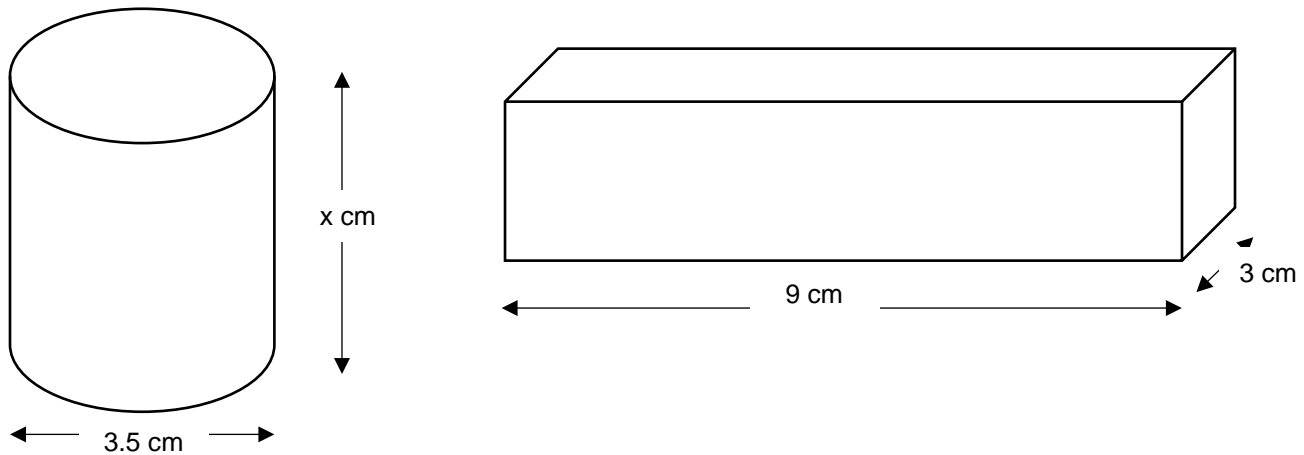

Information about the chocolates and cookies

- The chocolates measure 3 cm x 1.5 cm x 1.5 cm.
- The cookies have a diameter of 3.4 cm and a height of 1.4 cm.
- The cookies cost \$0.45 to make.
- The chocolates cost \$0.20 to make.
- The boxes cost \$0.0005 per cm^2 .
- The wrapping paper costs \$ 0.0295 per sheet.

Appendix B – Loyalty Program Information

Loyalty Program: Option #1

- For every dollar that customers spend, they get 1 point.
- For every 50 points, they get \$5 dollars off.
- They can cash in their points every time they earn 50 points.

Loyalty Program: Option #2

- For every dollar that customers spend, they get 10 points.
- Each point gives them \$0.01 off.
- They can cash in their points at any time.

Loyalty Program: Option #3

- For every dollar that customers spend, they get 5 points.
- The points work on a sliding scale as shown below.
- They can only cash in their points once they hit the point levels indicated below.

Points	Discount
500	\$5
1000	\$15
1500	\$40
2000	\$100

Appendix C – Formula Sheet

Square/Rectangle/Parallelogram

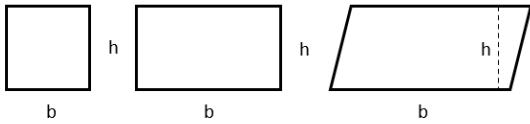

$$\text{Area} = b \times h$$

Circle

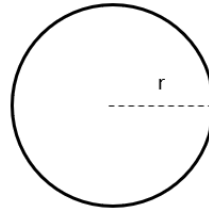

$$\text{Area} = \pi r^2$$

Cylinder (Surface Area)

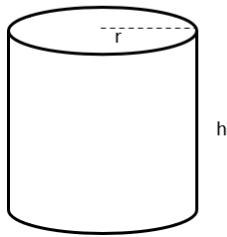

$$\text{Area} = (\pi \times d \times h) + 2(\pi r^2)$$

Regular Right Prism (Volume)

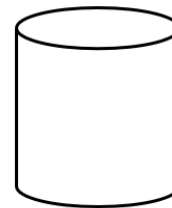
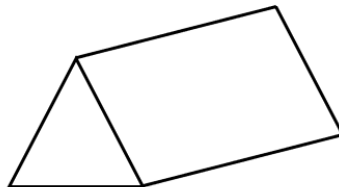
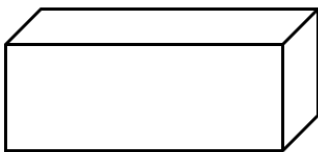

$$\text{Volume} = \text{Area of the base} \times \text{depth}$$

Appendix D – Answer Key

Sale price of cookies and chocolate

- Let x = the price of one cookie
- Let y = the price of one chocolate
- $7(5x + 8y = 44)$
- $-5(7x + 3x = 37)$
- $35x + 56y = 308$
- $-35x - 15y = -185$
- $\frac{41y}{41} = \frac{123}{41}$
- $y = 3$
- $5x + 8(3) = 44$
- $5x + 24 = 44$
- $\frac{5x}{5} = \frac{20}{5}$
- $x = 4$

The price of one cookie is \$4, and the price of one chocolate is \$3.

Triple 10 Deal

10 cookies at \$4 a cookie = \$40

10 chocolates at \$3 a chocolate = \$30

The two combined would cost \$70 - \$10 (combo savings) = \$60

The package would therefore cost \$60.

Dimensions of the container and box

- Surface area of the box: $9 \times 3 \times 3 = 81 \text{ cm}^2$
- Surface area of the cylinder: $2\pi r^2 + 2\pi rh = 81 \text{ cm}^2$

$$2\pi(1.75)^2 + 2\pi(1.75)h = 81 \text{ cm}^2$$

$$19.23 + 10.99h = 81 \text{ cm}^2$$

$$\frac{10.99h}{10.99} = \frac{61.77}{10.99}$$

$$h = 5.62 \text{ cm}$$

Costs of food and packaging

- The cost of the packaging:
 - The surface area of both the box and the container is 81 cm^2 .
 - The cost of producing the box and the container is $\$0.0005/\text{cm}^2$.
 - Therefore, the box and container cost $\$0.0005/\text{cm}^2 \times 81 \text{ cm}^2 = \0.0405 .
- Cost of the wrapping paper is $\$0.0295/\text{sheet}$. One sheet is needed for each box or container.
- Cost of a cookie container:
 - The area of the base of the container can hold one cookie.
 - The container is 5.64 cm in height, and each cookie has a height of 1.4 cm: $5.64 \div 1.4 = 4.03 \rightarrow 4$ cookies in each container.
- Total cost of producing each cookie package:
 - $\$0.45/\text{cookie} \times 4 \text{ cookies} = \1.80
 - Total cost = cost of container + cost of wrapping + cost of cookies
 - Total cost = $\$0.0405 + \$0.0295 + \$1.80 = \1.87
- Total cost of producing each chocolate box:
 - There will be 12 chocolates per box ($3 \times 2 \times 2$)
 - The cost of the chocolates is 12 chocolates \times $\$0.20/\text{chocolate} = \2.40
 - Total cost = cost of container + cost of wrapping + cost of chocolate
 - Total cost = $\$0.0405 + \$0.0295 + \$2.40 = \2.47
- The cost of making and packaging each cookie container is $\$1.87$, and the cost of making and packaging each chocolate box is $\$2.47$.

Graphs for each Loyalty Program Option

- Option #1

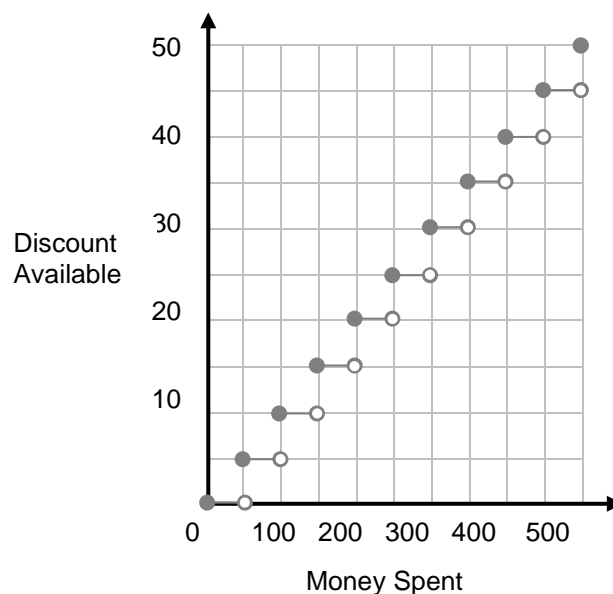

- Option #2

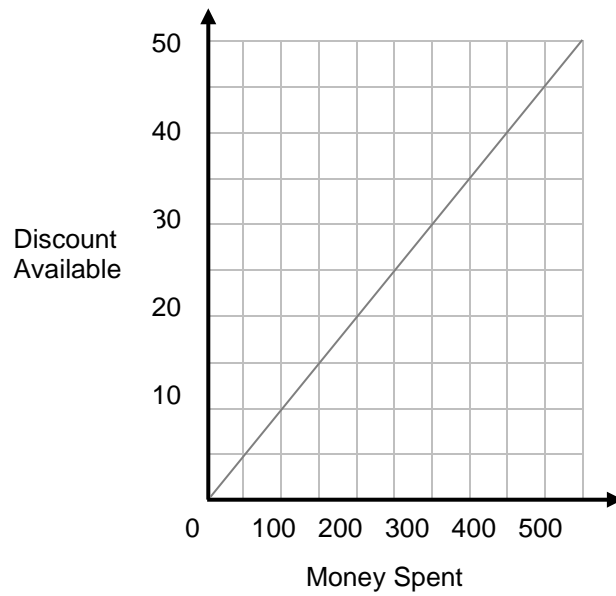

- Option #3

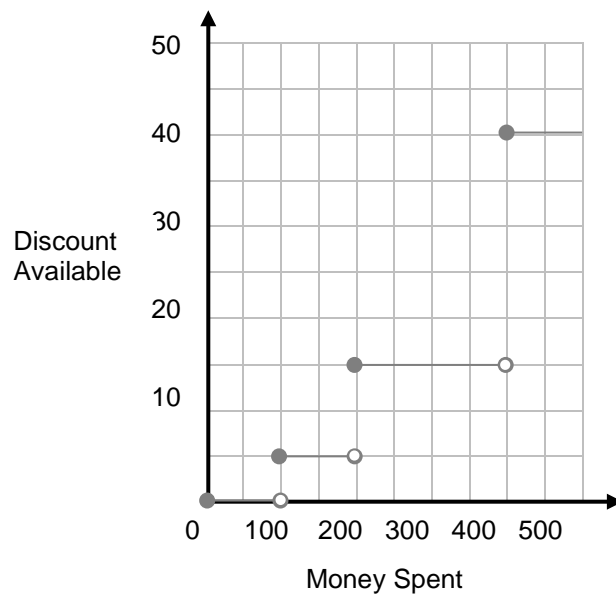

Burning Questions

Information for students

Centralia, Pennsylvania was a small coal mining town established in the 1860s around massive deposits of coal. Unfortunately, some of the underground coal in the old mines caught fire and has been burning very, very slowly for more than 50 years.

The residents were relocated and most of the buildings have been torn down. Smoke and steam rise from the ground and from the cracked, sunken roads over the fires.

In this activity, you will learn more about this smouldering underground fire and use your knowledge of science and technology to answer questions about the fire and its impact.

Instructions

- Read the information provided in Appendix A and answer the questions.
- Answers are provided in Appendix B.

Materials required

- Paper and writing materials
- Device with Internet access (optional)
- Appendices

Information for parents

About the activity

Children should:

- read the information in Appendix A and answer the questions
- apply their knowledge of the fire triangle, combustion, and the carbon cycle to answer questions

Parents could:

- read the information to their child, if necessary
- discuss the answers with their child

Appendix A– Burning Questions

Information for students

How did the fire start?

No one really knows for sure how the underground fire started. One of the most widely accepted ideas is that the fire started in 1962, when the town burned some of the garbage in its dump. It is thought that the fire in the dump, although intentional, accidentally spread to a nearby entrance to an old coal mine.

What happens when coal burns?

Coal contains carbon (C). Burning coal involves the combustion of carbon, as shown below:

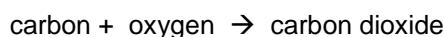

Why does the coal keep burning?

As shown by the fire triangle, combustion can occur when there is fuel and an oxidizing agent (oxygen), and the ignition temperature has been reached.

One of the reasons that the coal continues to slowly burn under Centralia is that there is a tremendous amount of fuel present, as the coal deposit is large.

Another reason is that the combustion of coal releases a lot of heat. Given that the fire is underground, the heat does not readily escape. Therefore, it is difficult to reduce the temperature below the ignition temperature of the coal.

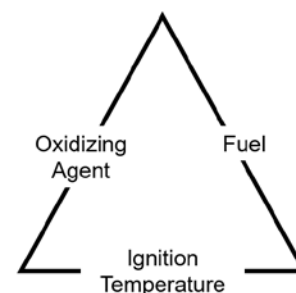

Is this a unique phenomenon?

There are many examples of these slow, smouldering fires in coal deposits or coal seams around the world. For example, it is estimated that the underground fire at Burning Mountain in Australia has been slowly burning for 6 000 years.

Now that you have some background information about the situation in Centralia, answer the questions on the next page.

Questions

Extinguishing the fire

Several attempts have been made to extinguish the fire. These attempts have been unsuccessful due to a variety of factors, including the size and nature of the coal deposits, technical difficulties and time and budget constraints.

1. Three of the attempted methods used to extinguish the fire are described below. For each of the methods, use the combustion triangle to explain why, in theory, the method could have worked.
 1. Spray the fire with water
 2. Dig a trench through the coal deposit ahead of the fire



3. Fill spaces in the old mines with sand and crushed rock
2. It was determined that the cost and risks involved in extinguishing the fire outweighed the benefits, so the fire in Centralia continues to slowly burn. However, some new methods for extinguishing the fire have been proposed because of renewed concerns about the impact of this and other coal seam fires on the environment.

One proposal is:

- Pump a nitrogen foam into all of the spaces around the old mines and coal deposits. The foam quickly expands to fill all available space and smothers the fire.
- Once the fire is extinguished by the nitrogen foam, pump a second foam full of microbes into the spaces around the old mines and coal deposits. Microbes are microscopic, single-celled organisms such as bacteria. The microbes undergo cellular respiration.

Explain, using the fire triangle, how using a microbe foam could prevent the fire from reigniting.

Impact of the fire

3. The fire releases a lot of heat. In the documentary, *The Town That Was*, by Chris Perkel and George Roland (Dog Player Films), one resident stated that the owner of the local gas station noticed that some gasoline had escaped from the underground storage tanks. Some reports noted that the temperature of the gasoline in the underground tanks was higher than normal.

Do you think it is possible that some gasoline escaped from the storage tanks when they were exposed to the heat released from the fire? Explain why or why not.

Science & Technology

4. Sink holes started to appear in the ground in different locations above the coal fire. Sink holes form when the surface of the ground collapses into an empty space underneath.

Using what you know about the combustion reaction, explain why sink holes formed.

5. Researchers are studying the impact of these fires on global warming. Use what you know about the carbon cycle and combustion to explain how the Centralia fire and other underground coal fires could contribute to global warming.

References

Images created by K. Davey, 2020

<https://www.earthmagazine.org/article/hot-hell-firefighting-foam-heats-coal-fire-debate-centralia-pa>

<https://www.nytimes.com/2002/01/15/science/sunken-fires-menace-land-and-climate.html>

<http://files.dep.state.pa.us/Mining/Abandoned%20Mine%20Reclamation/AbandonedMinePortalFiles/Centralia/CentraliaFrequentlyAskedQuestions.pdf>

Appendix B – Answers for Burning

The answers below outline some of the main points that could be addressed. Your scientific explanations should be more fully developed and can include drawings when appropriate.

1. a) As water absorbs heat, spraying the fire with water can reduce the temperature of the fire. The hope is that the water will reduce the temperature below the ignition temperature so that combustion cannot occur.
b) Digging a trench removes the fuel source from the fire.
c) The sand and crushed rock could smother the fire. That is, by covering the fuel source (coal) with another substance that does not combust, the coal cannot mix with the oxygen in the surrounding air. Therefore the oxidizing agent is removed and combustion cannot occur.
2. The microbes undergo cellular respiration, which consumes oxygen. Therefore this second foam will remove some of the oxygen from the air surrounding the coal deposits and hopefully prevent further combustion of the coal (reduced amount of oxidizing agent).
3. Given that the volume of the contents of the storage tanks would increase slightly when the temperature increases, it is possible that some of the contents may have escaped. The pressure inside the tanks may have increased slightly, pushing some of the contents out.
4. In the combustion reaction, solid coal is a reactant and carbon dioxide gas is a product. Sink holes formed because some of the solid coal under the ground was consumed and was no longer present to support the surface of the ground.
5. The combustion of coal releases carbon dioxide gas into the atmosphere. Carbon dioxide gas is a greenhouse gas and therefore contributes to the greenhouse effect, which leads to warmer temperatures.

The Importance of Healthy Snacking!

Information for students

Activity 1: Discover healthy snacks!

- As a Secondary IV or V student, you have probably been deciding what snacks you eat and when you eat them for a few years now. Healthy snacking can be an important part of your daily eating routine, as it can help you get all the nutrients you need. However, we live in a food culture that makes unhealthy snacks very accessible and very tempting. Preparing nutritious snacks in advance and bringing them with you when you leave the house can help you keep your snacking choices nutritious and delicious.
- Scroll through [this website](#) to explore snack recipes from Canada's Food Guide.
- If you do moderate-to-vigorous physical activity regularly throughout the week, check out the [Smart Snacks for an Active Lifestyle](#) by the Dietitians of Canada.
- What recipes stuck out to you? For what reason?
- Choose your favorite recipe and make it!
- How did it taste? Would you make it again?

Activity 2: Do a fun HIIT training challenge!

- Try this fun and challenging home workout:
 - Video: [HIIT Home Workout for beginners](#)
- What was the easiest exercise for you and why?
- What was the most challenging exercise and why?
- If necessary, adapt the movements to your abilities.

Materials required

- Ingredients for the chosen recipe

Information for parents

About the activity

Students should:

- learn how to prepare simple and healthy snacks
- try the workouts provided

Parents could:

- provide their children with the necessary ingredients
- do the workout with their children or help them be more autonomous during the activity

What Is Reconciliation?

Information for students

Last week we learned about National Indigenous Peoples Day, which is celebrated in Canada on June 21. We explored ways that this holiday can be celebrated that would honour Indigenous people and their culture.

This week, the goal is to better understand the history and current realities of Indigenous people. This knowledge will help you realize the crucial need for truth, justice and reconciliation between Indigenous and non-Indigenous people. By watching the recommended videos, you will learn the role all Canadians have in repairing and reconciling the relationship.

This short video describes the meaning of reconciliation: https://www.youtube.com/watch?v=hE_08EQbWRI.

The next two videos are clips from the documentary series *8th Fire*:

- 8th Fire, Part 1: https://www.youtube.com/watch?v=cb9f2L2u_JQ
- 8th Fire, Part 2: <https://www.youtube.com/watch?v=JOeGtkp-HSQ>

After watching the short videos in the *8th Fire* series, reflect on the following questions:

- What did you learn from the two videos that you did not know before?
- What was most shocking or disturbing about the information given in the videos?
- What are some current realities Indigenous people are facing in Canada (think about health care, education, the environment and funding)?
- What contributions have Indigenous culture, values and knowledge made to Canadian law, lifestyle and culture?
- What can you do to repair and reconcile the relationship between Indigenous and non-Indigenous people?
- Does having a holiday such as National Indigenous Peoples Day help repair the relationship?

Materials required

- Device with Internet access

Information for parents

- watch the videos with your child
- discuss some of the reflection questions with your child

Growing Pains

Information for students

Québec, Ontario, Nova Scotia and New Brunswick were the first four provinces of the new country of Canada in 1867, but they would not be the last. Manitoba (1870), British Columbia (1871) and Prince Edward Island (1873) would join Canada in the years following Confederation. Today, Canada is composed of 10 provinces and 3 territories, each with its own history of how it came to be included in the story of Canadian federalism.

- Click [here](#) to access an online version of your *Reflections* History textbook. You can use this link even if your class uses a different textbook.
Pages 84-91 will teach you a little about the territorial expansion of the Dominion of Canada, and how it affected Indigenous populations.
- If you do not have access to the Internet, read pages 84-91 of your *Reflections* textbook. If you do not have your textbook, you can look at the historical documents on the following pages to help you with the activities.
- Now that you have learned about the territorial expansion of the Dominion of Canada, and how it affected Indigenous populations, do the following activities:
 - **identify a difference** between the territory of the Dominion of Canada in 1867 and 1873
 - **establish a connection** between documents by differentiating between two of the Canadian government's reasons for settling the West: providing land to newly arrived Canadians and protecting the West from American annexation
 - **determine a consequence** of the Métis' fear of losing their lands, way of life and culture
 - **determine a change** that took place in the lives of Indigenous peoples after Confederation

Materials required

Useful resources, depending on personal preferences and availability:

- Device with Internet access (ideal)
- Writing materials (paper, pencil, etc.)

Information for parents

About the activity

Children could:

- do further research on the topic using resources like [The Canadian Encyclopedia](#)

Parents should:

- discuss the ideas presented and potential answers with their child

History of Québec and Canada

- Documents 1 and 2 present maps from two different points in Canada's history. **Identify a difference** between the territory of the Dominion of Canada in 1867 and 1873.

Document 1

The Dominion of Canada, 1867

Source: Sylvain Fortin et al., *Reflections.qc.ca: 1840 to Our Times*, History of Québec and Canada, Secondary IV (Montréal: Chenelière Éducation, 2018), 51.

Document 2

The Dominion of Canada, 1873

Source: Sylvain Fortin et al., *Reflections.qc.ca: 1840 to Our Times*, History of Québec and Canada, Secondary IV (Montréal: Chenelière Éducation, 2018), 84.

History of Québec and Canada

Answer:

2. There were several reasons for the government of Canada's desire to settle the West.
Establish a connection between Documents 3 and 4 by differentiating between two of these reasons:
- providing land to newly arrived Canadians
 - protecting the West from American annexation

Place the correct number in the boxes provided below.

Document 3

Government poster, circa 1890



Library and Archives Canada

Document 4

"In addition, the American purchase of Alaska in 1867 brought fears that the United States would attempt to link its western territories [via] British Columbia. Such fears were made worse by a small but vocal annexation movement on Vancouver Island."

Library and Archives Canada

History of Québec and Canada

Providing land to newly arrived Canadians	Protecting the West from American annexation

- When the Dominion of Canada acquired Western territory in 1869, approximately 10 000 Métis lived in the Red River region. The Métis saw these new colonists as a threat. **Determine a consequence** of the Métis' fear of losing their lands, way of life and culture.

Document 5

The Métis uprisings of 1869 and 1885



Source: Sylvain Fortin et al., *Reflections.qc.ca: 1840 to Our Times*, History of Québec and Canada, Secondary IV (Montréal: Chenelière Éducation, 2018), 85.

Answer:

- Residential schools were government-sponsored religious schools that were established for Indigenous children. Residential schools were created by Christian churches and the Canadian government. **Determine a change** that took place in the lives of Indigenous peoples after Confederation because of these residential schools.

History of Québec and Canada

Document 6

“In 1886, at the age of twelve years, I was lassoed, roped and taken to the Government School at Lebret. Six months after I enrolled, I discovered to my chagrin that I had lost my name and an English name had been tagged on me in exchange...When you were brought here [the school interpreter later told me], for purposes of enrolment, you were asked to give your name and when you did, the Principal remarked that there were no letters in the alphabet to spell this little heathen’s name and no civilized tongue could pronounce it.”

Daniel Kennedy (Ochankuga’he), former student at Qu’Appelle Residential School

Source: <http://www2.uregina.ca/education/saskindianresidentialschools/ochankugahe-daniel-kennedy/>

Document 7

“[W]hen an Indian comes out of these places it is like being put between two walls in a room and left hanging in the middle. On one side are all the things he learned from his people and their way of life that was being wiped out, and on the other side are the whiteman’s ways which he could never fully understand since he never had the right amount of education and could not be part of it. There he is, hanging in the middle of two cultures and he is not a whiteman and he is not an Indian.”

John Tootosis, former student at Delmas School

Source: The Final Report of Truth and Reconciliation Commission of Canada, Canada’s Residential Schools, Vol. 1, 190.

Document 8

“There was a death every month on the girls’ side and some of the boys went also. We were always taken to see the girls who had died. The Sisters invariably had them dressed in light blue and they always looked so peaceful and angelic. We were led to believe that their souls had gone to heaven, and this would somehow lessen the grief and sadness we felt in the loss of one of our little schoolmates.”

Louise Moine, former student at Qu’Appelle Residential School

Source: <http://www2.uregina.ca/education/saskindianresidentialschools/louise-trottier-moine/>

Answer:

Appendix – Growing Pains

Information for students

Answers:

1.

By 1873, British Columbia had become a province **OR** Manitoba had become a province **OR** Prince Edward Island had become a province **OR** The North-Western Territory and Rupert's Land had been acquired by the Dominion of Canada.

**Other answers may be possible.*

2.

Providing land to newly arrived Canadians	Protecting the West from American annexation
3	4

3.

The Métis rebelled **OR** The uprising of 1869 (The Red River Rebellion) **OR** The uprising of 1885 (The North-West Rebellion).

4.

Many Indigenous children no longer remembered their Indigenous languages **OR** Many Indigenous children no longer practised their traditional ways of life **OR** Many Indigenous children were no longer connected to their culture.

**Other answers may be possible.*